

cerwin
vega
mobile



VEGA

SUBWOOFER U2



U82DU2/U84DU2/U102DU2/U104DU2
U122DU2/U124DU2/U152DU2/U154DU2

MANUAL

Cerwin Vega Mobile Subwoofers

Congratulations for purchasing Cerwin Vega Mobile subwoofers for your car audio system. You have chosen Cerwin Vega Mobile because you deserve the best!

Cerwin Vega Mobile speakers are designed and engineered to reproduce great sound quality for many years of listening enjoyment in your vehicle! We highly recommend that your new speakers be installed by an authorized Cerwin Vega Mobile dealer. Your authorized dealer can professionally assemble / disassemble the interior of your vehicle and set the proper subwoofer placement for ideal sound quality.

If you decide to install the subwoofers by yourself, please thoroughly read through this manual before getting started. This manual will help familiarize yourself with these speakers and guide you through the installation process and procedures.

Please contact your local authorized Cerwin Vega Mobile dealer if you have any questions regarding the instructions in this manual.

If you require additional assistance, please contact the Cerwin Vega Mobile Technical Support Department during business hours at 213-261-4161

Features

V82D _{v2} / V84D _{v2}	- 8 INCH SUBWOOFER
V102D _{v2} / V104D _{v2}	- 10 INCH SUBWOOFER
V122D _{v2} / V124D _{v2}	- 12 INCH SUBWOOFER
V152D _{v2} / V154D _{v2}	- 15 INCH SUBWOOFER

- Proprietary Deep Drawn Stamped Cast Vega Basket
- Optimized High Power Motor Structure
- Parabolic One Piece Stamped Carbon Fiber Polypropylene Cone
- Vented Pole Piece For Additional Cooling For Extended Play
- Double Stitched VEGA RED Santoprene Surround
- Proprietary Horizontal Mounted Spring Loaded Terminal
- High Power Integrated Impedence Selector
- Vega Concealed Mounting Gasket

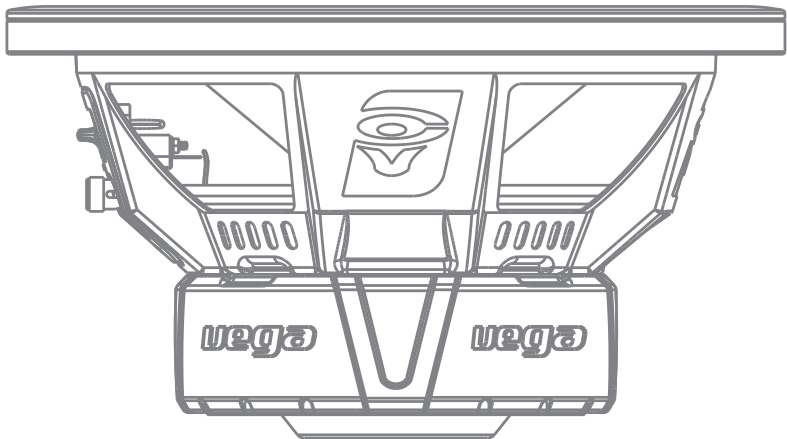

Specifications

Dimension	Unit	V82D/4D _{v2}	V102D/4D _{v2}	V122D/4D _{v2}	V152/4D _{v2}
Total Diameter (A)	in. (mm)	8.74" (222mm)	10.7" (272mm)	12.6" (320mm)	15.78" (401mm)
Mounting Diameter (B)	in. (mm)	7.08" (180mm)	8.82" (224mm)	10.7" (272mm)	13.62" (346mm)
Screw Hole Dia. (C)	in. (mm)	0.63" (16mm)	0.7" (18mm)	0.7" (18mm)	0.82" (21mm)
Mounting Depth. (D)	in. (mm)	4.4" (112mm)	5.43" (138mm)	5.67" (144mm)	7.28" (185mm)
Magnet Dia. (E)	in. (mm)	4.64" (118mm)	5.63" (143mm)	6.53" (166mm)	7.08" (180mm)
Displacement (ft ³ /L)	cu. ft/ liters	0.03ft ³ (0.96L)	0.06ft ³ (1.67L)	(0.09ft ³ / 2.5L)	(0.15ft ³ / 4.18L)
Weight (.lbs/Kg)	pounds/kilos	7.lbs (3.15Kg)	11.5 .lbs (5.2Kg)	17.lbs (7.7Kg)	20.2 .lbs (9.2Kg)

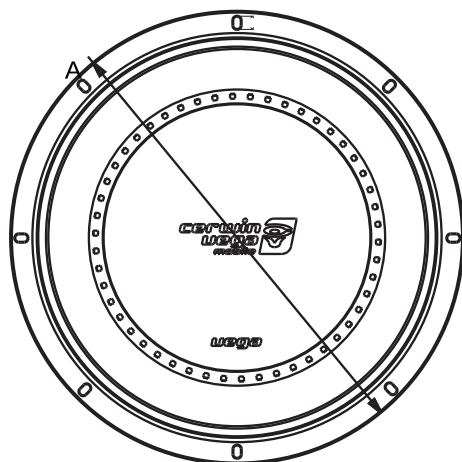
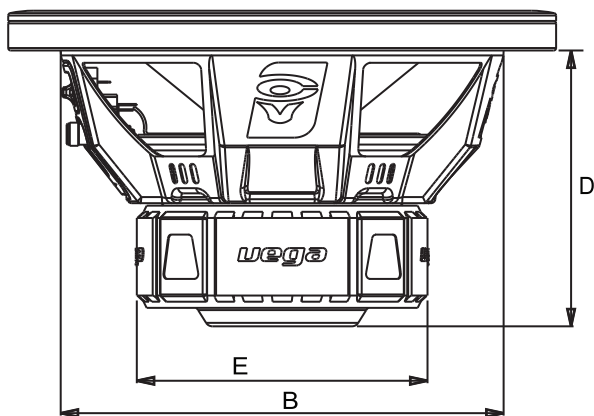

Thiele/Small Parameters

Parameter (unit)	V82Dv2	VP84Dv2	V102Dv2	V104Dv2	V122Dv2	V124Dv2	V152Dv2	V154Dv2
SPL (dB)	81.5	82	85	85.5	84.8	85.6	86.5	86.7
Re (Ω) [series]	2.0 / 2.0	4.0 / 4.0	2.0 / 2.0	4.0 / 4.0	2.0 / 2.0	4.0 / 4.0	2.0 / 2.0	4.0 / 4.0
Qms	7.2	6.8	6.9	6.1	11.4	8	7.3	9.5
Qes	0.7	0.76	0.5	0.66	0.68	0.71	0.58	0.74
Qts	0.63	0.597	0.469	0.602	0.643	0.653	0.542	0.69
Fs (Hz)	34.4	34.1	29.1	34.5	26.7	27.4	19.6	22.1
Vas (L)	14.9	14.6	39.6	28	67	62.3	244.9	166.8
Cms (mm/N)	0.262	0.241	0.257	0.37	0.197	0.42	0.268	0.32
Mms (g)	81.7	81.6	116.8	118	180.2	184.6	246.7	255.2
Sd (m ²)	0.02	0.02	0.033	0.033	0.049	0.049	0.08	0.08
BL (T*M)	9.9	12.8	6.4	15.3	13.1	16.6	15.1	18.5
Xmax (mm)	13.5	13.5	17	17	17	17.3	24	18.1
Pwr (W) NOM/MAX	250 / 750	250 / 750	400 / 1100	400 / 1100	450 / 1300	450 / 1300	550 / 1500	550 / 1500

Integrated Impedance Selector

To help installation we at Cerwin-Vega Mobile designed a simple but effective single terminal Dual Voice coil setup. Simple pull out the terminal rotate it to the impedance desired. The impedance above the terminal is the impedance of the driver now, with only one set of speaker wires going to it. No complicated wiring anymore!!!

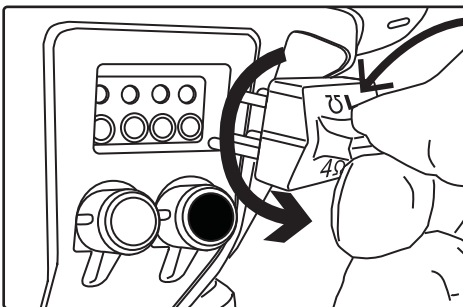

* The sub shown is wired into a 1 ohm load (1 Ω)

RECOMMENDED ENCLOSURES

(All measurements are calculated (Using 3/4" MDF))	Volume (net int.)	External Dimensions W _{depth} x H _{height} x D _{depth}	Volume (net int.)	Enclosure External Dimensions W _{depth} x H _{height} x D _{depth}	Slot Port Internal Dimensions P _{port} W _{width} x P _{port} or H _{height} x P _{port} Length	Port Extension Length "PE"
V82D _{v2} /4D _{v2}	0.5 ft ³ 14.9 litres	13.5" x 13.5" x 7.5" 343mm x 343mm x 215.5mm	0.75 ft ³ 21.23 litres	13.5" x 13.5" x 11.5" 343mm x 343mm x 292mm	1" x 10" x 22" 25.4mm x 254mm x 559mm	11.25" (285.75mm)
V102D _{v2} /4D _{v2}	0.75 ft ³ 21.2 litres	14" x 12.75" x 10" 356mm x 324mm x 254mm	1.25 ft ³ 35.375 litres	20.5" x 13.5" x 13.25" 519mm x 305mm x 273mm	1.25" x 12" x 22" 32mm x 305mm x 559mm	10.75" (273mm)
V122D _{v2} /4D _{v2}	1.25 ft ³ 35.4 litres	18" x 14.25" x 12.5" 457mm x 362mm x 317.5mm	1.50 ft ³ 42.450 litres	22" x 15" x 13.25" 559mm x 381mm x 273mm	1.625" x 13.5" x 27" 41mm x 343mm x 666mm	15.75" (400mm)
V152D _{v2} /4D _{v2}	2.5 ft ³ 70.79 litres	18" x 18" x 18" 457mm x 457mm x 457mm	3.0 ft ³ 84.95 litres	18" x 18" x 21.5" 457mm x 457mm x 546mm	2.5" x 16.5" x 23" 63.5mm x 419.1mm x 584.2mm	9" (228")

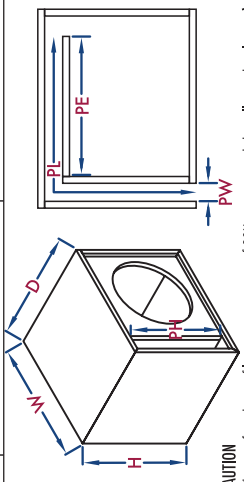
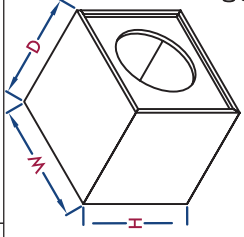
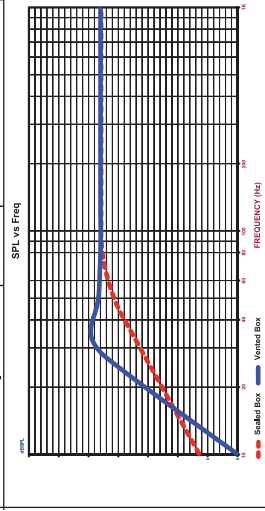

CAUTION

(The use of a sub-sonic filter set at a minimum of 30Hz is recommended on all vented enclosures.)



MINIMUM RMS POWER (50W BLACK AREA)
This lower amount of power will increase the longevity of the woofer, but will decrease the amount of output volume.

RECOMMENDED RMS POWER (100W GREEN AREA)
This is the optimum amount of power to provide the perfect balance output volume and woofer longevity.

MAXIMUM RMS POWER (250W RED AREA)
This is the maximum amount of power the woofer is designed to operate safely under. Only a moderate volume increase is gained (<1.7dB) at this higher power level. Operating beyond this power level will void your warranty.

Warranty

Thank you for purchasing a Cerwin Vega Mobile product and we hope to provide you with countless hours of listening enjoyment.

Please take a brief moment to register your new product. By registering your new product, you will receive benefits such as:

- Important product notifications that may pertain to your purchase.
- Confirmation and record of ownership in case of loss or theft.
- Knowledgeable customer service and technical assistance pertaining to your product.

Register your new product by completely filling out this Product and Warranty Registration card or register online at www.cerwinvegamobile.com.

Registration is voluntary and failure to register will not diminish your limited warranty rights.

Limited Warranty (U.S.A.)

Cerwin Vega Mobile warrants all of our amplifiers and speakers to be free of defects in materials and workmanship for a period of one (1) year.

This warranty is non-transferable and applies only to the original purchaser from an authorized Cerwin Vega Mobile dealer. If service is required and necessary under this warranty due to manufacturing defect or malfunction, then Cerwin Vega Mobile will repair and/or replace defective product with either new or remanufactured like product at no charge at our discretion.

Damage to product caused by the following will not be covered under this warranty: abuse, accident, misuse, neglect, modifications, repairing attempts, seller/installer misrepresentation.

This warranty does not cover any incidental, consequential, or cosmetic damage due to accidents or normal wear and tear, nor does it cover the cost of removing or reinstallation of the product.

Warranty is void if the product's serial number has been removed, defaced, and/or tampered with.

Warranty Procedure:

We recommend that you contact your Cerwin Vega Mobile authorized dealer where your original purchase was made to initiate all warranty claims. Our authorized dealers can guide you through the warranty procedure to ensure that your claim will be processed in a timely manner. All warranty returns must be accompanied with a proof of purchase (a copy of the original sales receipt) and be shipped freight prepaid to our facility with an RA (Return Authorization) number clearly marked on the outside of the package. Direct returns from consumers or non-authorized dealers will be refused if shipped without a valid RA number authorized by Cerwin Vega Mobile beforehand.

INTERNATIONAL

Products purchased outside of the U.S.A. are covered only by that country's distributor and not by Cerwin Vega Mobile U.S.A.

Please Ship All Warranty Claims With Pre-Authorized RA Number To:

CV&DA Holdings, Inc.
ATTN: Customer Service Department
3761 S. Hill St.
Los Angeles, CA 90007 USA

Please Contact Customer Service for Further Warranty Information:

U.S.A.
Tel: 213-261-4161 / Fax: 213-947-4767



**3761 South Hill Street
Los Angeles 90007, USA
P 213-261-4161 / F 213-947-4767**

WWW.CERWINVEGAMOBILE.COM

**©2019 Cerwin Vega Mobile All rights reserved.
(a division of CV & DA Holdings, Inc.)**